

S12H-SSTD50-R5CB2-500

Gear Tooth Speed Switch

- Speed Switch
- Transistor output-ferrous target activated
- Regulated input, NPN with 5k pull-up
- Stainless 12x1mm x 52mm housing
- Integral 4 pin male 12mm micro connector



CUSTOMER FOCUSED ENGINEERING + MODULAR DESIGN

Part Description: **S12H-SSTD50-R5CB2-500**

Housing	Sensor Type & Function	Electrical Option	Connection Type	User Defined Frequency
S = Stainless Steel, Thread Pitch M12x1, 52mm Long	Speed Switch Gear Tooth & Ferrous Targets	Regulated Input NPN w/5k Pull up	CB2 = Integral 4 Pin Male 12mm Micro Connector	Switch Frequency xxx in Hz

Modify, update, or enhance any sensor with our modular features and functionality.

HOUSING - Aluminum, stainless steel, plastic, threaded, flange mount, customer specific

ELECTRICAL - Every sensor function available in various electrical options (NPN, PNP, TTL, etc.)

CONNECTION - Deutsch, Amphenol, many other brands, free end wires, pigtails, any length

Need a Custom Sensor Solution?... Send us your application specific requirements at sensorso.com

'Steel Gears & Ferrous Target Actuated Speed Switch with Transistor Output'

Overspeed, Underspeed, Zero-Speed

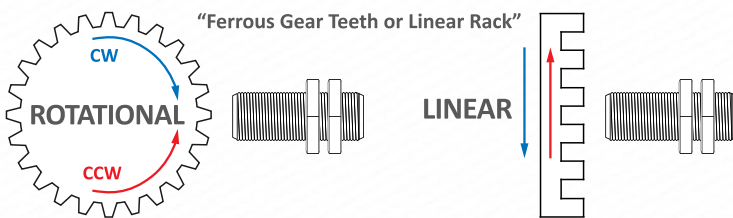

DESCRIPTION

- Speed switch output turns on/off dependent on factory programmed frequency.
- 500 Hz switch point indicates if sensor is seeing more or less than 500 "teeth" per second.
- Single channel digital square wave output for resolving actual speed.
- Detects gears and other ferrous targets using Hall Effect Technology
- Capable of detecting 0-32 pitch gears, bolt heads, holes in steel plates, and other ferrous targets
- No orientation required. Use lock nuts to set air gap within range of target

OUTPUTS

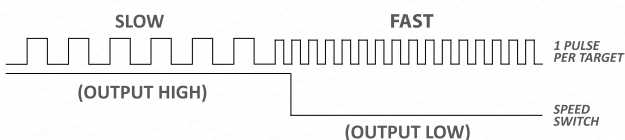

FEATURES

- Ferrous Target Speed Switch
- No Orientation Required
- Add -xxx in Hz to End of PN – contact factory for custom switch point models

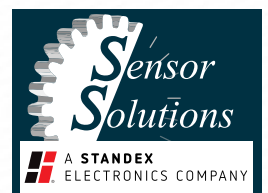

S12H-SSTD50-R5CB2-500

Gear Tooth Speed Switch

OTHER OPTIONS

As well as these Ferrous Target Speed Switches, we offer Magnet / Magnet Tape activated Speed Switches, and Gear Tooth Speed Switches designed to work with standard gears. We have options for relay outputs, NPN outputs, and TTL outputs.

Note: Check our website or contact us to discuss any of our magnetic speed, count, and position detection sensors.

Electrical Specifications	Conditions	Min	Max	Unit
Temperature Range	Operating	-40	+110	Deg C
Supply Voltage, Vcc	Over temperature	+8	+30	Volts DC
Supply Current	Into Vcc, Vcc=12V	5	16	mA
Internal Pull up Resistor	Vcc to Vout	4.9	5.1	kOhms
Vol, Low Level Vout	Vcc = 12V, Rload >100k	0.0	0.7	Volts
Voh, High Level Vout	Vcc = 12V, Rload >100k	11.75	12	Volts
Overspeed TRIP Frequency	Output goes low above	490	505	Hz
Underspeed Release Freq.	Output goes high below	470	485	Hz
ESD (like product qualified)	Nondestructive	-	2000	Volts
EMI (like product qualified)	20k to 1 G Hz	-	20	V / M

Rev D

S12H Housing, 303 Stainless Steel, M12X1, 52mm Long

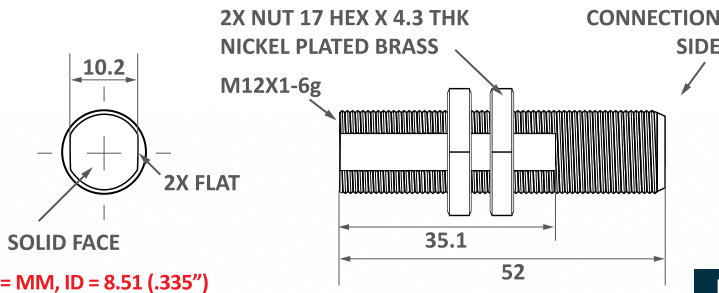

Rev B

CB2, Integral 4 Pin Male 12mm Micro Connector

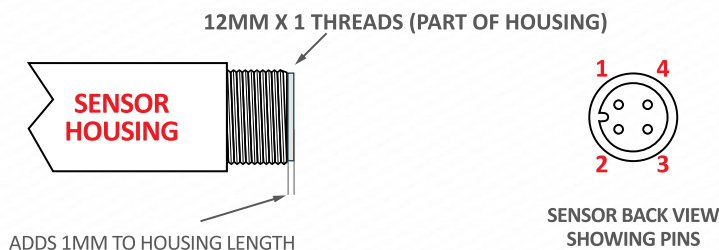

Rev A

Absolute Max Limits	Min	Max	Unit
Supply Voltage, Vcc-Gnd	-32	+32	Volts
Voltage at Output	-.3	30	Volts
Sink Current into Output	-	50	mA
Short Circuit Prot. Vout-Gnd	-	Indef.	Minutes
Short Circuit Prot. Vout+Vcc	-	None	Minutes

Environmental Specifications

Corrosion Resistance	500 hours salt spray ASTM B-117
Installation Torque	23 Foot-Pounds Maximum
Enclosure	Nema 1,3,4,6,13 & IEC IP67
Vibration	10 G's 2 to 2000 Hz Sinusoidal
Mechanical Shock	100 G's, 11 ms Half-Sine

Sensor Characteristics

Output State at 0 Speed: High (Transistor Off)

Air Gap Range, Targets	Min	Typ	Max
.22" wide, .65" apart, .30" deep:	.000"	.070"	.140"*
.12" wide, .29" apart, .25" deep:	.000"	.045"	.090"*
.10" wide, .17" apart, .17" deep:	.000"	.028"	.055"*
.06" wide, .10" apart, .10" deep:	.000"	.015"	.030"*
TRIP Frequency Accuracy, Output LOW	.98%	1.0%	1.01%*
RELEASE Frequency Accuracy, Output HIGH	.99%***	1.0%	1.02%

STOP DETECT TIME, Output returns high after sudden stop 10ms (Typical)

* Gap the sensor less than MAX GAP.

** Output is LOW if teeth are passing by faster than 1.02 * Trip Frequency.

*** Output is HIGH if teeth are passing by slower than 0.99 * Release Frequency

Convert RPM to Hz

Over/Under Speed Trip Points are in Hz, pulses per second.

To convert RPM (Revolutions per Minute) to Hz, you need to know the target's pulses per revolution, "N". A 20-tooth target produces 20 pulses, so N=20.

$$\text{Hz} = \text{RPM} * (N / 60). \text{ Or } \text{RPM} = \text{Hz} * (60 / N).$$

Example: For a 20-tooth target and 500 Hz trip point, RPM = 500 * (60 / 20) so the output switches low at 1500 RPM.

Connections Chart

Pin 1	Vcc	Pin 3	Ground
Pin 2	1 Pulse per Target	Pin 4	Speed Switch Output

CB2-SSTD50

OTHER MATING CONNECTORS AND CABLES AVAILABLE

S12H-SSTDSO-R5CB2-500

Gear Tooth Speed Switch

Sensor Function

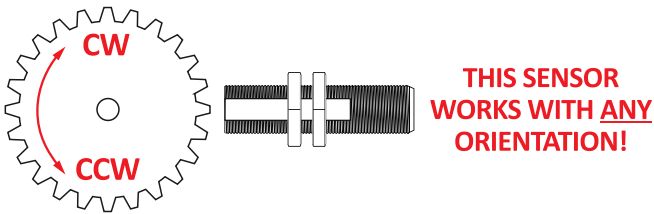

S12H-SSTDSO

Marking

DATE CODE, THIS SURFACE

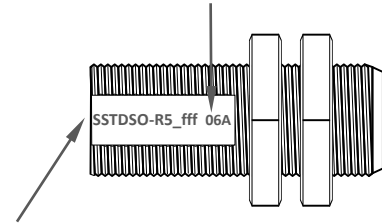

CHARACTERISTIC-OPTION_TRIP SPEED MARKED ON THIS SURFACE
fff = SWITCH FREQUENCY IN Hz #

R5, Regulated, 5k Resistor

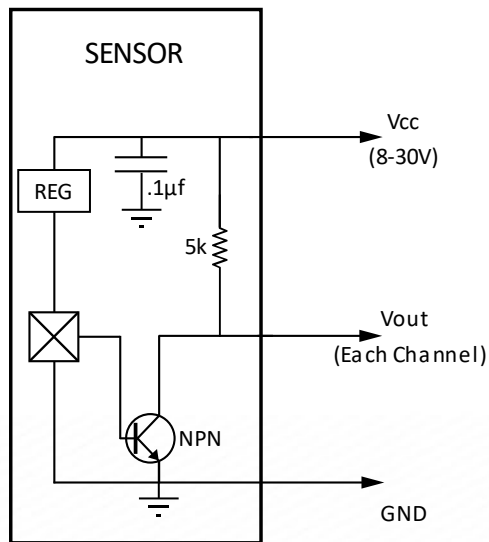

Date Code 'YYM' YY = YEAR, M = MONTH

A	JAN	D	APR	H	JUL	L	OCT
B	FEB	E	MAY	J	AUG	M	NOV
C	MAR	G	JUN	K	SEP	N	DEC

Handling Instructions

DO NOT CONTACT FACE TO FACE

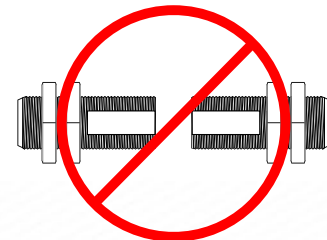

CONTACT WITH OTHER MAGNETS MAY REDUCE THE MAXIMUM OPERATING GAP

Please note: All technical specifications on this series datasheet refer to the standard product range. Modifications in the sense of technical progress are reserved. For general information only. For more specific information, please consult the product datasheet, available upon request.

This series datasheet could contain technical inaccuracies or typographical errors. Changes are periodically made to the information herein. These change will be incorporated in future revisions.

For deviating values, most current specifications and products please contact your nearest sales office.