

MINIATURE HIGH VOLTAGE 1kVDC REED RELAYS

DESCRIPTION

Standex Electronics introduces a brand new MHV series of miniature high voltage reed relays. This surface mount (SMD) series body measures only L17.2mm x W10.5mm x H8.5mm. Making the MHV series the smallest in the entire high voltage offering.

These Reed Relays are designed to switch system voltages levels up to 1kVDC and withstand even higher breakdown voltages with a minimum of 3kVDC, while ensuring low leakage currents. The MHV combines the excellent electrical and thermal properties in combination with the compact design.

The MHV's efficient power consumption coupled with its high voltage, low leakage current, and high isolation properties make this series ideal in any device containing a battery management system. MHV relays are particularly suitable where isolation measurements between low and high voltage circuits are frequently monitored. Typical applications include electric vehicles, photovoltaic systems, test and measurement, and medical equipment.

FEATURES

- Smallest High Voltage SMD Relay - up to 1,000 VDC Switching Voltage
- Breakdown Voltage 3 kVDC across the open switch
- 5 kV Dielectric Strength Coil/Contact
- Off-State Leakage current in nanoampere range
- Effective power consumption
- Meets creepage and clearance distance requirements acc. to IEC 60664-1, ISO 6469-3, IEC 62109-1/2, IEC 60601-1
- Tested in acc. to AEC-Q200, UL approved
- In compliance with RoHS and REACH

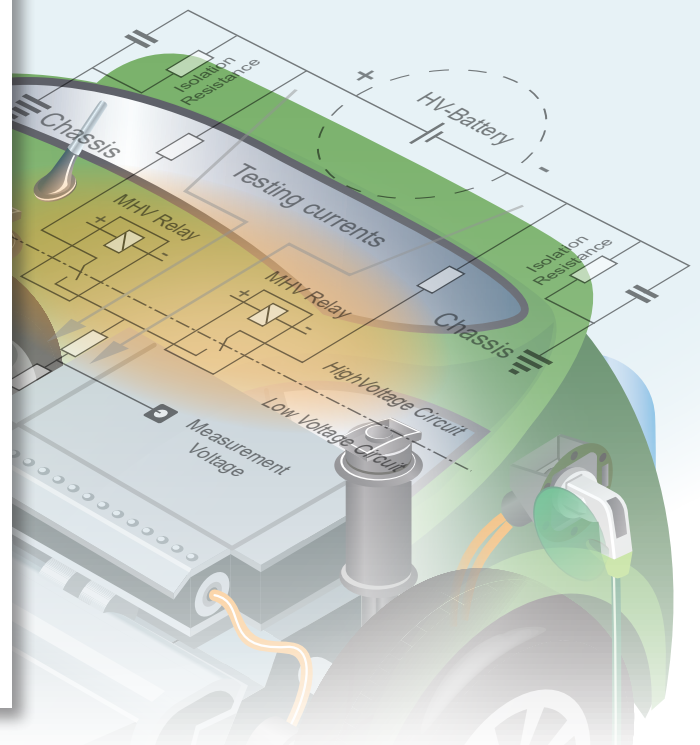
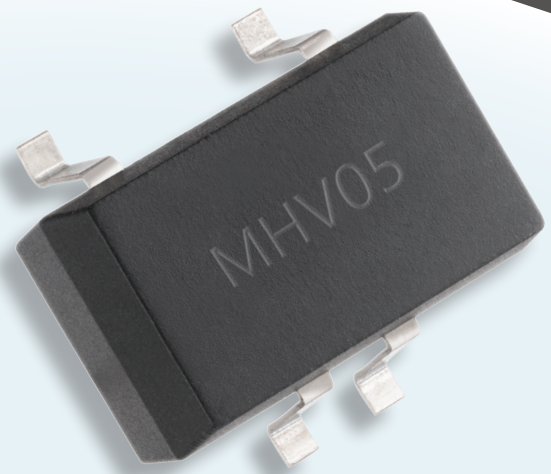

www.standexelectronics.com

Americas: +1.866.782.6339
info@standexelectronics.com

APAC: +86.21.37606000
salesasia@standexelectronics.com

EMEA: +49.7733.9253.200
salesemea@standexelectronics.com

MINIATURE HIGH VOLTAGE 1kVDC REED RELAYS

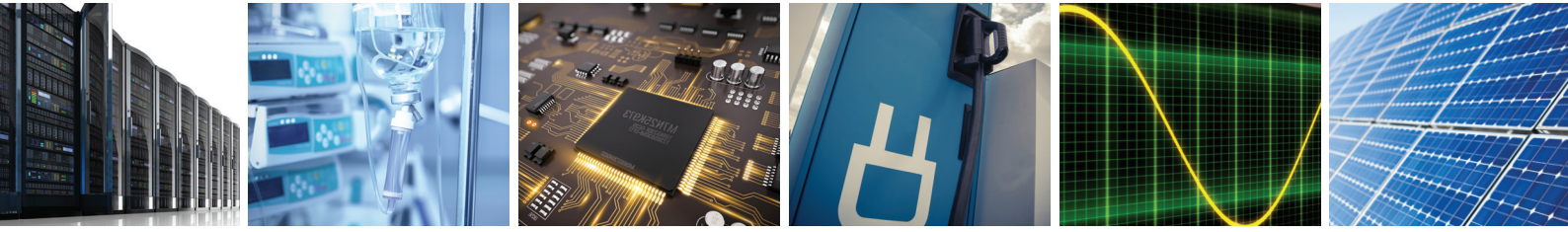

MHV SERIES

OPERATING CHARACTERISTICS

Coil Voltage:	5 VDC	Switching Current Max. :	0.7 A
Coil Resistance Typ.:	140 Ω	Carry Current (100% Duty Cycle) Max.:	1.25 A
Contact Form:	1 A	Insulation Resistance Min.:	10 ¹¹ Ω
Coil Rated Power:	180 mW	Off-State Leakage current Typ.:	3 nA
Switching Voltage Max.:	1 kVDC	Dielectric Strength (Coil to Contact):	5 kVDC
Breakdown Voltage Min.:	3 kVDC	Operating Temperature Max.:	-40 to 105°C

Please note: All technical specifications on this flyer refer to the standard product range. Modifications in the sense of technical progress are reserved. For general information only. For more specific information, please consult the product datasheet, available upon request.

DIMENSIONS MM [INCH]

Tolerances acc. to DIN ISO 2768-m

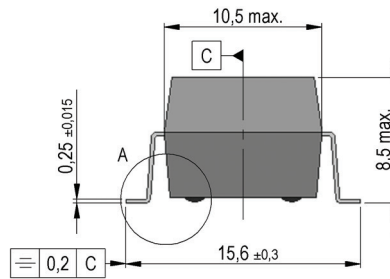
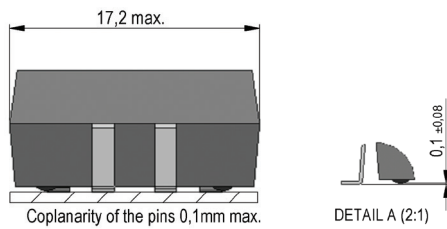

ISOMETRIC

Scale 1:1

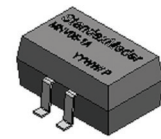

RECOMMENDED PAD LAYOUT (Top View)

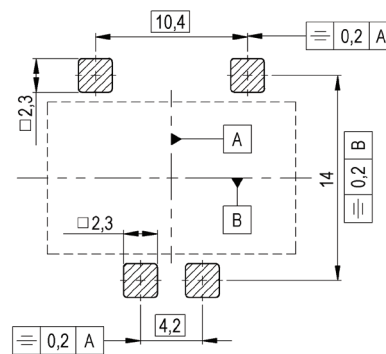
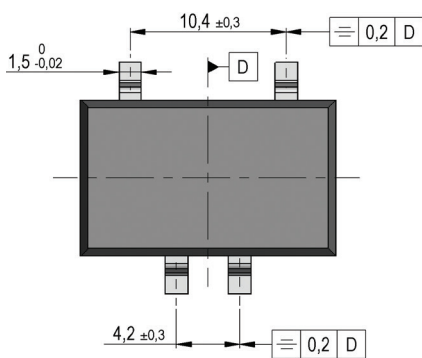

SCHEMATIC

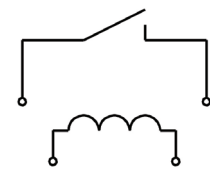

MARKING Acc. to EN60062 / Factory code



Automotive // Electric Vehicles // Battery Management Systems // Photovoltaic Inverters
Isolation Measurement // Medical Equipment // Automated Test Equipment // High Density Matrix

www.standexelectronics.com

Americas: +1.866.782.6339
info@standexelectronics.com

APAC: +86.21.37606000
salesasia@standexelectronics.com

EMEA: +49.7733.9253.200
salesemea@standexelectronics.com

