



# Application Alley

## Electronics - Reed Sensor

*Electric Toothbrushes Achieve Much Greater Reliability*

*Using Reed Sensors*

## Introduction

For years manufactures of electric toothbrushes have used mechanical slide switches to turn on and off the power to the toothbrush. The mechanical slide switches are subject to very harsh environments having to deal with chemically active toothpastes, acidic saliva, and running water at various temperatures and acidity/alkalinity levels. This environment attacks the electrical contacts in the slide switch and in many cases, after a short time the slide switch fails to turn the toothbrush on and off. Going to a Reed Sensor has eliminated this problem.

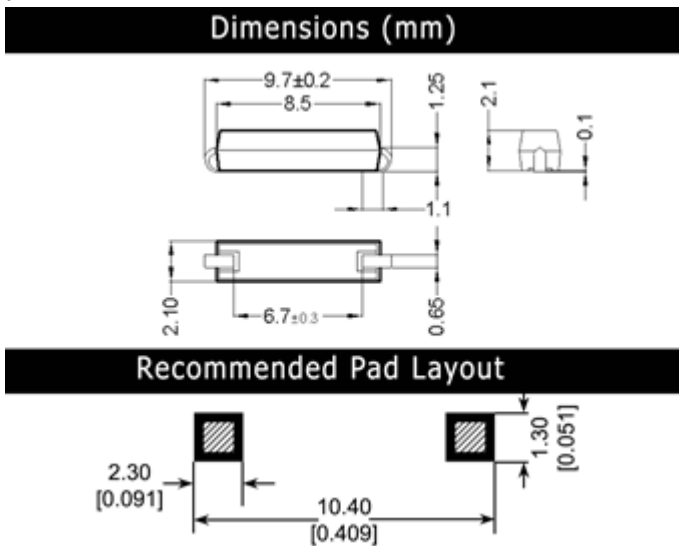

Figure 1. MK17-x-3 Sensor physical layout

## Features

- Reed contact is seal in the casing of the toothbrush
- Reed contact never comes in contact with the outside environment
- Reed switch is hermetically sealed
- Magnet and switch are isolated by the toothbrush casing
- The magnet is not affected by the environment
- Millions of operations reliably
- Surface mount or thru hole mounting
- Contacts dynamically tested

## Applications

- Electric toothbrush
- Activation approach may be used anywhere when concerned about switching in a dirty environment (dust, dirt, moisture, acidic environment, alkaline environment)

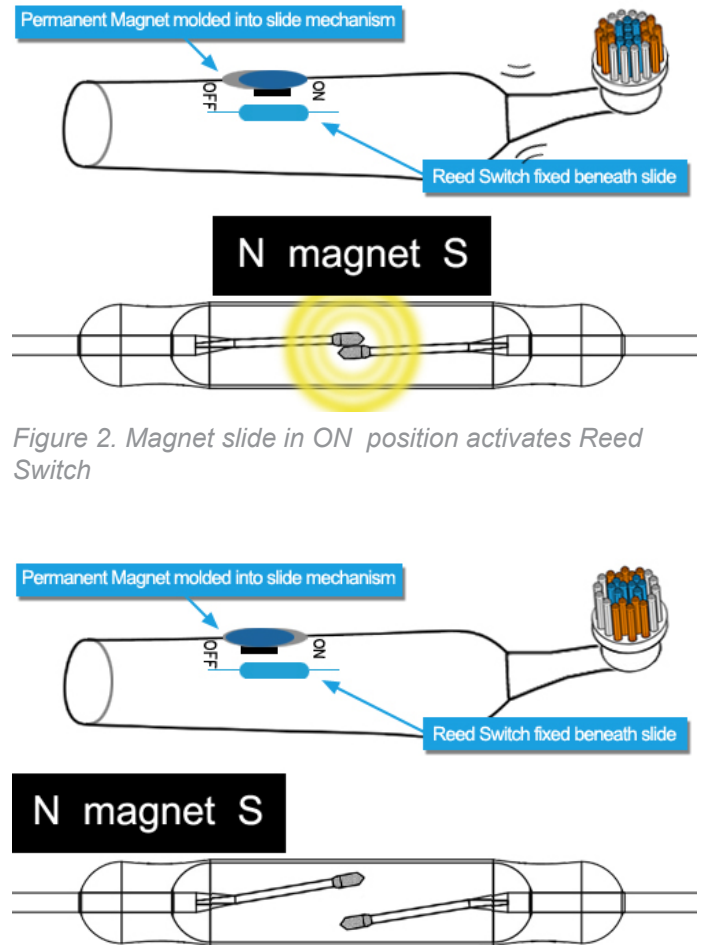

Figure 2. Magnet slide in ON position activates Reed Switch

Figure 3. Magnet slide in OFF position deactivates Reed Switch

## Harsh Switching Environments call for fully sealed Reed Sensors

Electric toothbrushes have had reliability issues for years because of the faulty operation of the use of on/off mechanical slide switches that are not fully sealed from the environment. To prevent this designers have had to go to fully sealed slide switches which are much more expensive are still subject to some reliability issues dealing with the sealing of the slide switches.

The mechanical slide switches are still subject to very harsh environments having to deal with chemically active toothpastes, acidic saliva, and running water at various temperatures and acidity/alkalinity levels. This environment, if it leaks into the seal will attack the electrical contacts in the slide switch and in many cases, after a short time the slide switch fails to turn the toothbrush on and off.

The Reed Sensor is the best approach to solving this problem. It solves the reliability problem and represents a low cost solution. The on/off switch must be able to handle the following: 1. survive a bathroom atmosphere; 2. be able to survive being dropped three or more feet; 3. survive repeated contact with saliva (acidic); 4. survive contact hot and cold water baths; 5. and continue to work for several years.

The electronics are not affected by the above environment because they are safely packed away internally in the casing of the toothbrush. So the most vulnerable component is the on/off switch. The key feature of the reed sensor is its main component, the hermetically sealed reed switch, is also locked away in the sealed casing of the toothbrush where the other electronic components reside.

Specifications (@ 20°C) MK15 & MK06 Series			
	Min	Max	Units
<b>Operate Specifications</b>			
Must close distance	5	25	mm
Must open distance	5	25	mm
Hysteresis	Typical 50%		
<b>Load characteristics</b>			
Switching voltage		200	V
Switching current		0.5	Amps
Carry current		1.5	Amps
Contact rating		10	Watts
Static contact resistance		150	mΩ
Dynamic contact resistance	200		mΩ
Breakdown voltage	320		V
Operate time		0.5	msec
Release time		0.1	msec
Operate temp MK06	-20	85	°C
Storage temp MK06	-20	85	°C
Operate temp MK15	-20	130	°C
Storage temp MK15	-20	130	°C

## Dimensions (mm)

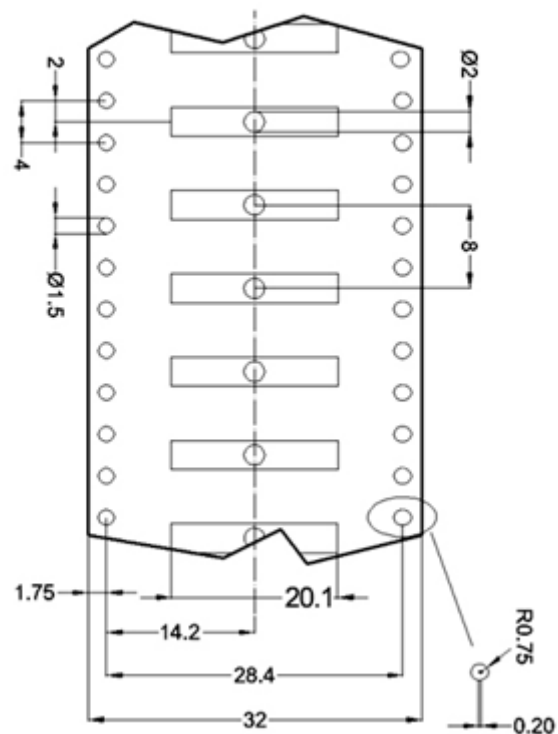













Figure 4. MK15 Tape & Reel

Surface Mount Sensor Series				Illustration
Series	Dimensions			
	mm	inches		
MK15	W	2.5	0.098	
	H	2.5	0.098	
	L	19.50	0.768	
MK16	W	2.3	0.091	
	H	2.3	0.091	
	L	15.60	0.614	
MK17	W	2.1	0.083	
	H	2.1	0.083	
	L	9.61	0.378	
MK22	W	2.7	1.060	
	H	2.3	0.091	
	L	15.60	0.614	
MK23-35	W	2.2	0.087	
	H	1.95	0.077	
	L	15.75	0.620	
MK23-66	W	2.2	0.087	
	H	2.7	1.060	
	L	19.60	0.772	
MK23-87	W	2.0	0.079	
	H	2.1	0.083	
	L	15.60	0.614	
MK23-90	W	2.54	0.100	
	H	3.05	0.120	
	L	24.9	0.980	

A magnet is molded into the plastic form replacing the slide switch. When the molded magnet slide is moved, its magnetic field influences the strategically placed reed switch internal to the casing closing the contacts; thereby turning on the toothbrush operation. In a like manner when the magnet slide is slid back the magnetic influence is lost to the reed

switch, opening the contacts and turning off the toothbrush. In this case, the magnet and its molded slide mechanism never comes in physical contact with the reed switch. This sets up the biggest single reason why this approach represents the best technology for the design.

Consider some of the below options in surface mount and through hole versions for an electric toothbrush or other similar application using a sliding switch to power a handheld device.

Through Hole Sensor Series				Illustration
Series	Dimensions			
	mm	inches		
MK06-4	W	3.3	0.130	
	H	3.3	0.130	
	L	12.06	0.475	
MK06-5	W	2.8	0.110	
	H	3.2	0.126	
	L	14.30	0.563	
MK06-6	W	3.3	0.130	
	H	4.2	0.165	
	L	17.24	0.679	
MK06-7	W	3.3	0.130	
	H	4.2	0.165	
	L	19.78	0.779	

Find out more about our ability to propel your business with our products by visiting [www.standexelectronics.com](http://www.standexelectronics.com) or by giving us a [hello@standexelectronics.com](mailto:hello@standexelectronics.com) today! One of our engineers or solution selling sales leaders will listen to you immediately.

## About Standex Electronics

Standex Electronics is a worldwide market leader in the design, engineering, and manufacture of standard and custom electro-magnetic components, including magnetics products and reed switch-based solutions.

Our magnetics offerings include planar, current sense, and conventional low- and high-frequency transformers and inductors. Reed switch-based solutions include Meder, Kent, and KOFU brand reed switches, as well as a complete portfolio of reed relays, and a comprehensive array of fluid level, proximity, motion, water flow, HVAC condensate, hydraulic pressure differential, capacitive, conductive and inductive sensors.

We offer engineered product solutions for a broad range of product applications in the transportation, automotive, medical, test and measurement, military and aerospace, aviation, HVAC, appliance, security and safety, and general power and industrial markets.

Standex Electronics has a commitment to absolute customer satisfaction through a partner, solve, and deliver approach. With a global organization that offers sales support, engineering capabilities, and technical resources worldwide – we implement customer driven innovation that puts the customer first.

For more information on Standex Electronics, visit us on the web at [standexelectronics.com](http://standexelectronics.com).

### Contact Information:

#### Standex Electronics

World Headquarters  
4538 Camberwell Road  
Cincinnati, OH 45209 USA

#### Standex Americas (OH)

+1.866.STANDEX (+1.866.782.6339)  
[info@standexelectronics.com](mailto:info@standexelectronics.com)

#### Standex Electronics Asia (Shanghai)

+86.21.37606000  
[salesasia@standexelectronics.com](mailto:salesasia@standexelectronics.com)

#### Standex Electronics Europe (Germany)

+49.7731.8399.0  
[info@standexelectronics.com](mailto:info@standexelectronics.com)

#### Standex Electronics India (Chennai)

+91.98867.57533  
[kkasaragod@standexelectronics.com](mailto:kkasaragod@standexelectronics.com)

#### Standex Electronics Japan (Kofu)

+81.42.698.0026  
[sej-sales@standex.co.jp](mailto:sej-sales@standex.co.jp)

